



Ningbo Haitian Precision Machinery Co., Ltd.

H.Q. & Production Base1

No. 1688 Haitian road, Xiaogang, Beilun, Ningbo-315801, China.

Tel: +86-574-86182580/86182525

E-mail: hision@mail.haitian.com

Production Base2

No.235, Huangshan Road, Beilun District, Ningbo-315801 China.

Production Base3

No.188, Baodao Road, Lingang Industrial Zone, Changxing Island, Dalian-116317 China.

Production Base4

No.1 Haishun Road, Longjiang Town, Shunde District, Foshan-528303, China

HUATENG MACHINERY (SINGAPORE) PTE. LTD.

Office Address:

7 Temasek Boulevard #43-03A Singapore 038987

Website:

www.haitianprecision.com

V SERIES MACHINE CENTER

V / VH / VQ / Z

HISON

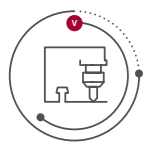

PRODUCT INTRODUCTION

The design of the machining center focuses on high efficiency, high precision, and high reliability. This series adopts a single-column fixed structure with a moving worktable, featuring a compact overall structure and small footprint. It is suitable for industries such as general machinery, automotive, instrumentation, textile machinery, and mold manufacturing.

V SERIES MACHINE CENTER

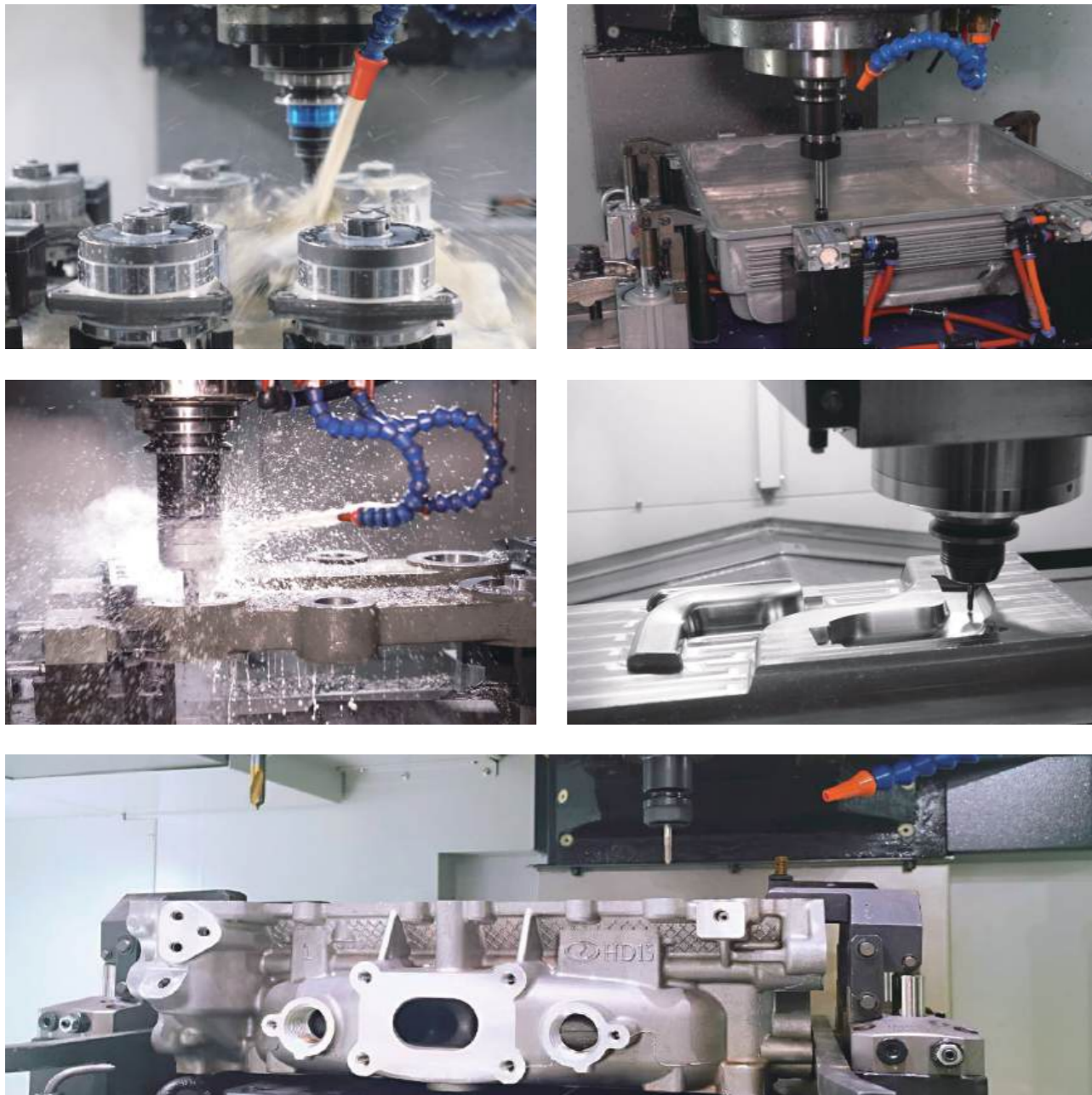

V6 [Page 05] **V12** [Page 06]

V8 [Page 05] **V13** [Page 06]

V10 [Page 05] **V15** [Page 06]



V8H [Page 11]

V10H [Page 11]



VQ6 [Page 15]

VQ9 [Page 15]

VQ11 [Page 15]

VQ13 [Page 15]



Z5 [Page 20]

Z7 [Page 20]



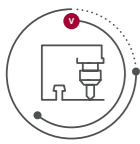

V SERIES

V series uses high-strength cast iron materials and adopts the large-span bed base and column structure to provide a solid foundation and stable performance for the machining tools. Equipped with mature spindle system and feed system, ensure the stability and reliability of the machine tool. Fully closed and capped protection, providing a good environment for operation.



High Rigidity Design

The bed and column has a large span, and all parts are made of high-quality cast iron to achieve superior shock absorption performance, support rigidity and excellent stability.



Full Enclosure

Full enclosure with the top cover: optimized and upgraded, no oil leakage, water leakage, leakage chips.

Tool magazine protection: Equipped with tool magazine protection, reduce the risk of iron filings entering the tool sleeve, improve the stability of the machine tool.

V SERIES

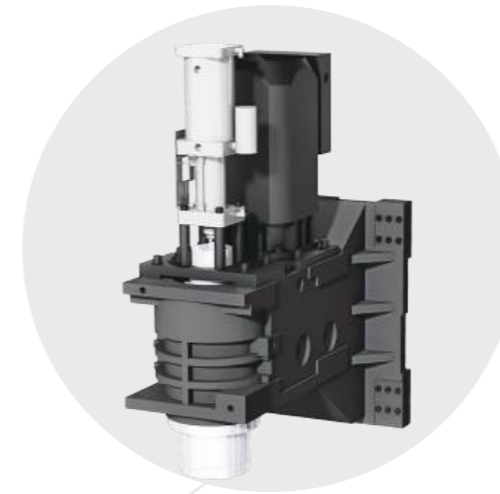

More Intelligent Design

Gravity axis power-off & emergency stop lifting: the gravity axis lifting protection function is added to prevent the spindle from colliding with the workpiece under the power-off&emergency stop condition.

Abnormal load detection function: anti-collision protection function is added to the machine tool to reduce the damage to the spindle.

Intelligent tool preparation mode: the tool magazine has the function of tool preparation in advance, preparing the next tool while processing, shortening the non processing time and improving the processing efficiency.



Tool Change Stability

Standard gas storage tank, so that the machine's gas path is not affected by the factory's external air source, so as to improve the stability of spindle tool change.

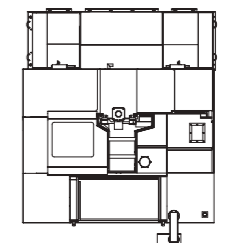
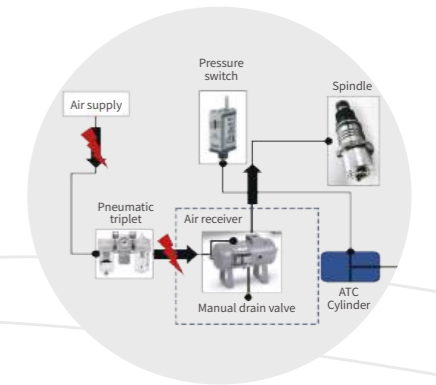

Standard internal rear chip conveyor

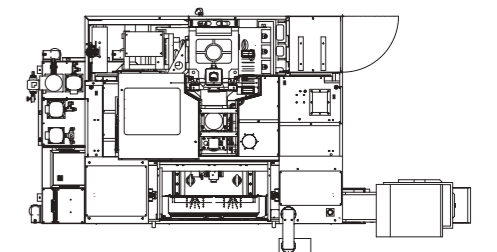
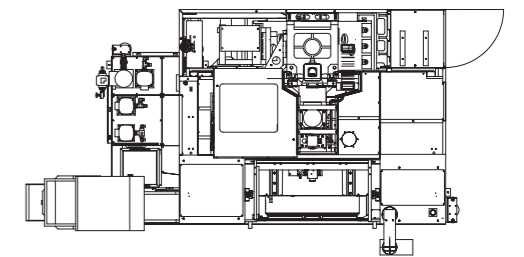

Diversified options for external chip conveyor

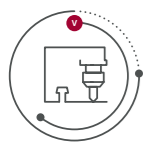

V SERIES

Items	Unit	V6	V8	V10
» Machining Range				
X travel	mm	600	850	1000
Y travel	mm	450	500	600
Z travel	mm	510	500	600
Spindle nose to table surface	mm	120-630	150-650	150-750
» Table				
Table size	mm	700×450	1000×500	1200×600
Table load	kg	350	600	800
T slot	mm	5×18×80	5×18×80	5×18×100
» Spindle				
Drive type		Belt drive	Belt drive	Belt drive
Max. spindle speed	rpm	8000	8000	8000
Spindle power (S1/S6)	kW	7.5/11	7.5/11	7.5/11
Spindle torque (S1/S6)	Nm	35.8/70	35.8/70	35.8/70
Spindle taper		BT40	BT40	BT40
Pull stud		MAS P40T-I (45°)	MAS P40T-I (45°)	MAS P40T-I (45°)
» Feed				
Rapid traverse (X/Y/Z)	m/min	48/48/48	36/36/36	36/36/36
Cutting feedrate (X/Y/Z)	m/min	20/20/20	15/15/15	15/15/15
» Tool Magazine				
Tool magazine capacity	T	24	24	24
Tool magazine type	-	Arm type	Arm type	Arm type
Max. tool dia. (Adjacent/vacant)	mm	Φ80/Φ150	Φ80/Φ150	Φ80/Φ150
Max. tool length	mm	300	300	300
Max. tool weight	kg	8	8	8
Tool change time	s	2.5	2.5	2.5
» Other				
Power capacity	kVA	30	30	30
Machine weight	t	4.5	6	6.5
Machine size (L×W×H)	mm	2130×2600×2600	2500×3400×2550	2800×3550×2700

Standard Configuration (Except V15)

1. Controller: Mitsubishi M80VB
2. 8000rpm belt drive spindle
3. 24T ATC
4. Pneumatic and lubrication system
5. Cutting cooling
6. Internal water flooding chip conveyor
7. Full enclosure with top cover
8. Air gun
9. 3-color signal lamp, working light
10. Standard accessories
11. External manual chip box
12. CE Mark (EU region)

Option Configuration (Except V15)

1. Controller: SIEMENS 828D (SW24)
2. Controller: FANUC 0i
3. 10000rpm belt drive spindle
4. 12000rpm directly drive spindle
5. Spindle oil chiller
6. CTS (2/3/7MPa)
7. Spindle ring spray
8. NC rotary table(4th)
9. Workpiece probe
10. Tool setter
11. ATC protection door
12. Water gun
13. Oil skimmer
14. Oil mist collector
15. External chain type chip conveyor and trolley
16. More suitable for Al chip of the water tank
17. AC for electric cabinet
18. Linear scale(except V6)

V SERIES

Items	Unit	V12	V13	V15
» Machining Range				
X travel	mm	1200	1300	1500
Y travel	mm	600	700	800
Z travel	mm	600	700	800
Spindle nose to table surface	mm	150-750	100-800	200-1000
» Table				
Table size	mm	1300×600	1400×700	1700×800
Table load	kg	600	1300	1500
T slot	mm	5×18×100	5×18×125	5×22×150
» Spindle				
Drive type		Belt drive	Belt drive	Gear box
Max. spindle speed	rpm	8000	8000	6000
Spindle power (S1/S6)	kW	7.5/11	11/15	15/18.5
Spindle torque (S1/S6)	Nm	35.8/70	52.5/95.5	491/607
Spindle taper		BT40	BT40	BT50
Pull stud		MAS P40T-I (45°)	MAS P40T-I (45°)	MAS P40T-I (45°)
» Feed				
Rapid traverse (X/Y/Z)	m/min	36/36/36	36/36/24	24/24/20
Cutting feedrate (X/Y/Z)	m/min	15/15/15	15/15/12	12/12/10
» Tool Magazine				
Tool magazine capacity	T	24	24	24
Tool magazine type	-	Arm type	Arm type	Arm type
Max. tool dia. (Adjacent/vacant)	mm	Φ80/Φ150	Φ80/Φ150	Φ110/Φ200
Max. tool length	mm	300	300	350
Max. tool weight	kg	8	8	18
Tool change time	s	2.5	2.5	4
» Other				
Power capacity	kVA	30	30	40
Machine weight	t	7	9.5	12
Machine size (L×W×H)	mm	3150×3550×2700	3320×3900×3200	5100×3100×3600

Standard Configuration (V15)

1. Controller: Mitsubishi M80VB
2. Gear box
3. Spindle oil chiller
4. 24T arm type tool magazine (BT50)
5. Pneumatic and lubrication system
6. Cutting cooling
7. Internal front screw chip conveyor
8. External chain chip conveyor
9. Full enclosure
10. Air gun
11. 3-color signal lamp, working light
12. Standard accessory
13. Z-axis nitrogen balance system (Z-axis box guide rail)
14. CE Mark (EU region)

Option Configuration (V15)

1. Controller: SIEMENS 828D (SW24)
2. Controller: FANUC 0i
3. CTS (2/3/7MPa)
4. Spindle ring spray
5. NC rotary table (4th)
6. Workpiece probe
7. Tool setter
8. Water gun
9. Oil skimmer
10. Oil mist collector
11. AC for electric cabinet
12. Linear scale

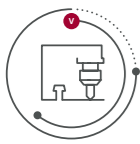

VH SERIES

VH series machine center is an upgraded version based on the V series, representing a new generation of high-speed machining centers. Equipped with a high-performance built-in spindle and a high dynamic response servo system, it delivers enhanced speed and efficiency in machining operations. This machine is widely applicable for high-speed precision machining of components in industries such as automotive, aerospace, and general machinery.

VH SERIES



Long-Span Bed

Long-span cast bed and columns ensure machining stability.

High-Speed, High-Performance Spindle

Standard built-in spindle with low rotational inertia, rapid start-stop response, high machining efficiency, and constant power output at high speeds.

Equipped with synchronized water-cooling circulation technology to effectively reduce thermal deformation of the spindle.



Excellent Chip Evacuation Capability

Standard with Y-axis rear protection chip flushing and a high-flow flushing pump, effectively preventing material chip accumulation on the Y-axis rear protection.

Enhanced Tool Magazine Protection

The tool magazine features a sloped guard for efficient chip and fluid management, minimizing contamination risks and boosting machine stability.

Brush systems further block chips and moisture, ensuring higher reliability.

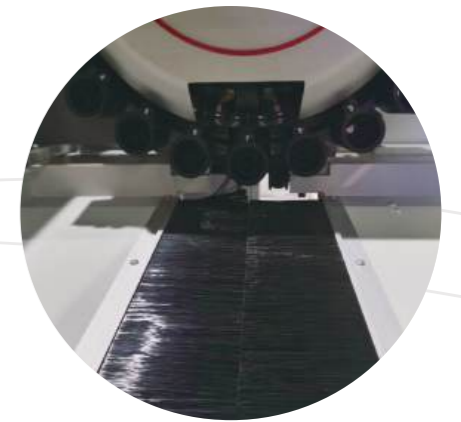

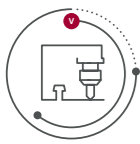

Machine Size

• V8H with rear chip conveyor (ST)

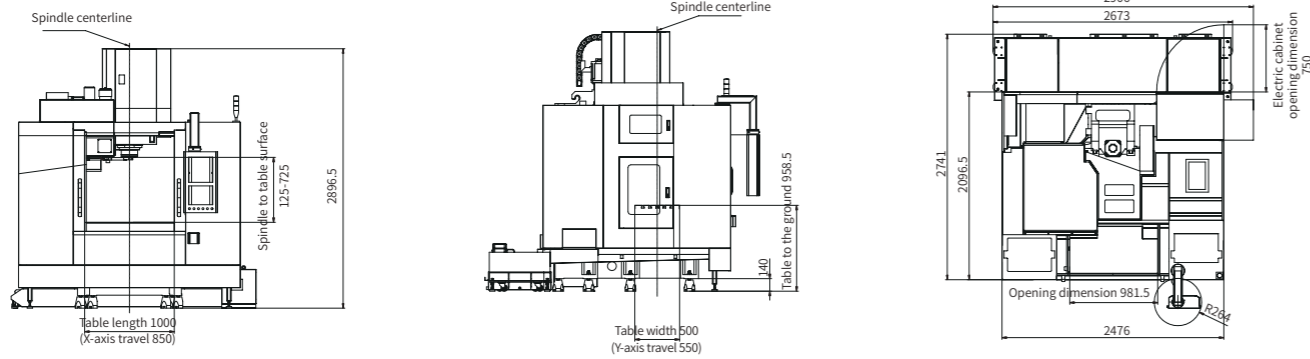

• V8H with front left chip conveyor (OP)

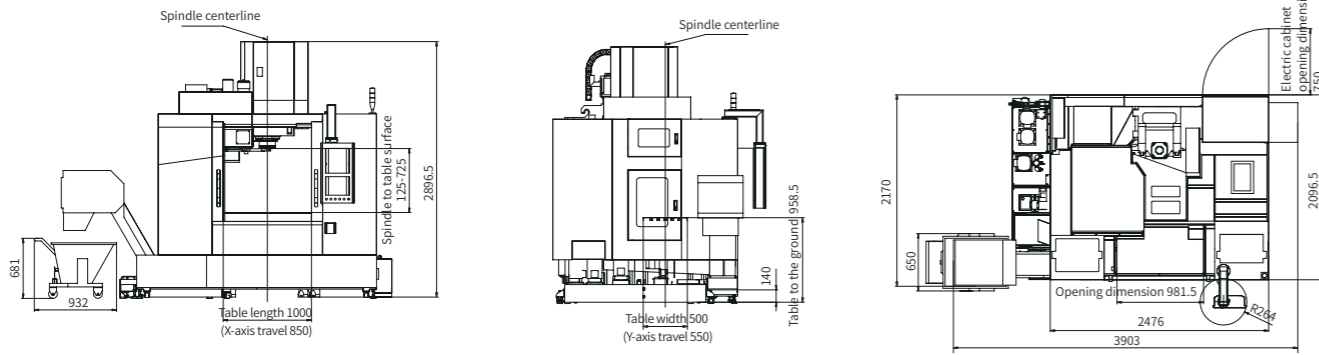

• V10H with rear chip conveyor (ST)

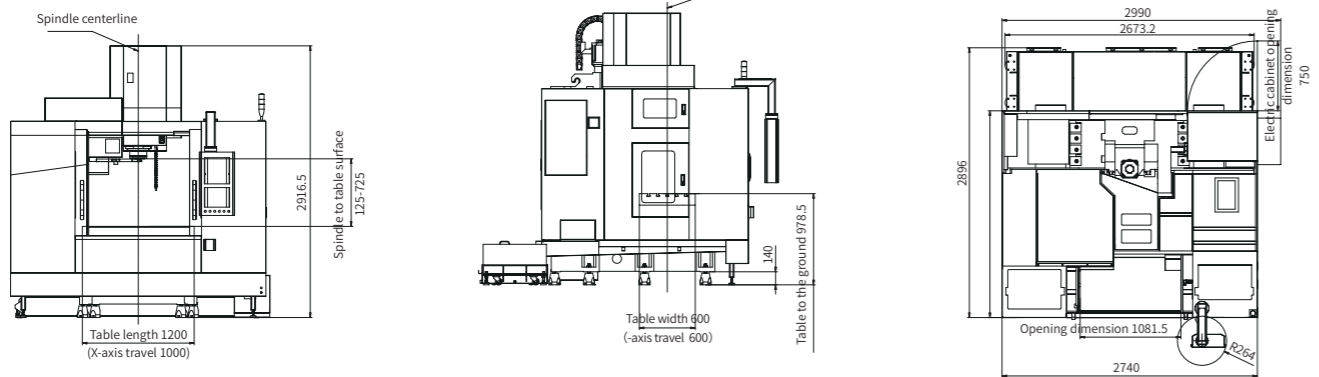

• V10H with front left chip conveyor (OP)

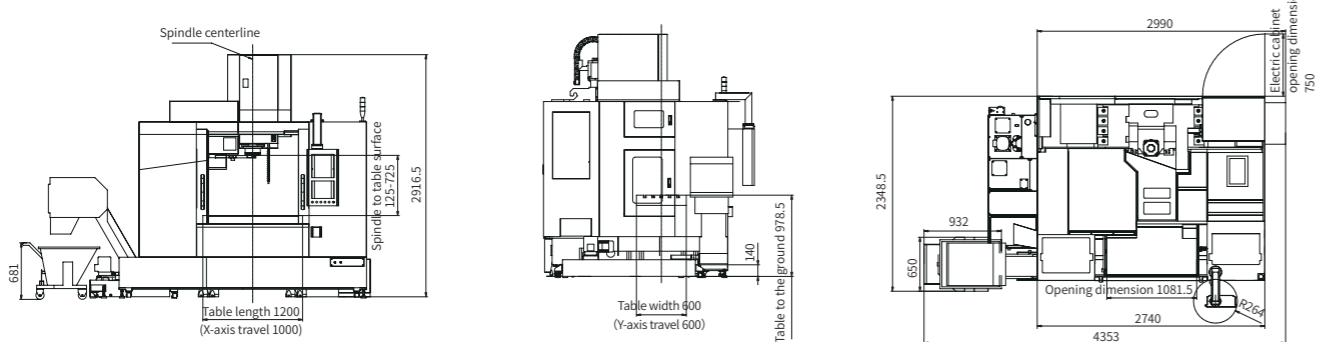

VH SERIES



- Robust manufacturing performance
- High rigidity structure
- Huge machining space
- Automation-ready and fixture-ready

- HISION developed high rigidity built-in spindle. Precision-matched integration for enhanced machine tool performance
- Superior structural, equipped with optional CTS, offers higher cost-effectiveness compared to direct-drive spindles.

• Typical Parts

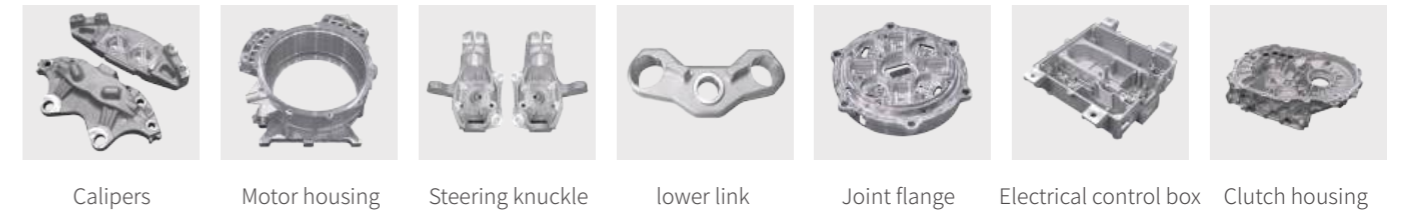

Power Torque Diagram

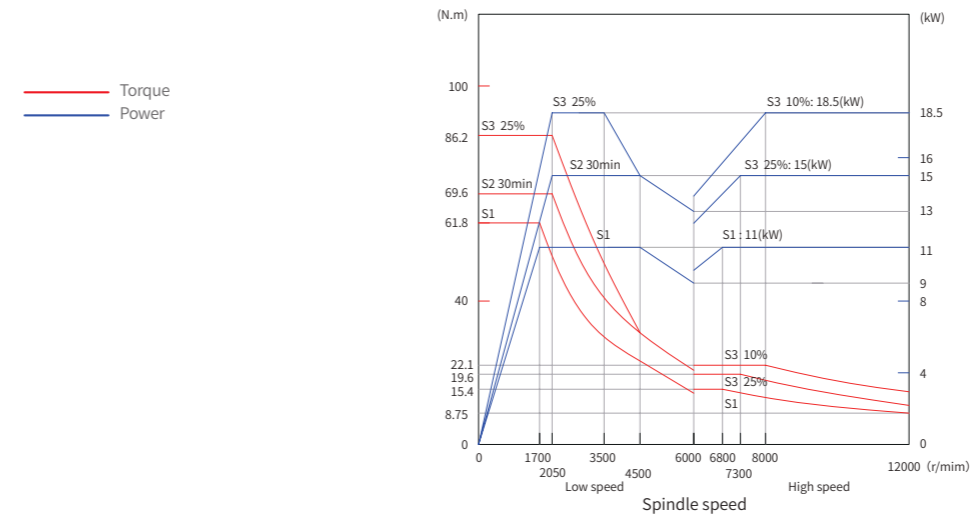

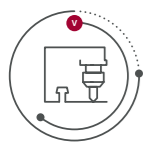

VH SERIES

Items	Unit	V8H	V10H
» Machining Range			
X travel	mm	850	1000
Y travel	mm	550	600
Z travel	mm	600	600
Spindle nose to table surface	mm	125-725	125-725
» Table			
Table size	mm	1000×500	1200×600
Table load	kg	500	800
T slot	mm	5×18×80	5×18×100
» Spindle			
Drive type		Built-in spindle	Built-in spindle
Spindle speed	rpm	12000	12000
Spindle power (S1/S3)	kW	11/18.5	11/18.5
Spindle torque (S1/S3)	Nm	61.8/86.2	61.8/86.2
Spindle taper		BT40	BT40
Pull stud		MAS P40T-I (45°)	MAS P40T-I (45°)
» Feed			
Rapid traverse (X/Y/Z)	m/min	48/48/48	36/36/36
Cutting feed rate (X/Y/Z)	m/min	20/20/20	20/20/20
» Tool Magazine			
Capacity	T	24	24
Type	-	Arm type	Arm type
Max. tool dia. (Adjacent/vacant)	mm	Φ80/Φ150	Φ80/Φ150
Max. tool length	mm	300	300
Max. tool weight	kg	8	8
Tool change time (T-T)	s	2	2
» Other			
Power capacity	kVA	25	30
Machine weight	t	5	5.6
Machine size (L×W×H)	mm	2430×2800×2800	2720×2900×2900

Standard Configuration

1. Controller: Mitsubishi M80VB
2. 12000rpm built-in spindle
3. 24T arm type tool magazine
4. Spindle cooling
5. Cutting cooling
6. Tool magazine protection
7. Internal rear flushing
8. External hopper type rear water tank
9. Full enclosure
10. 3-color signal lamp, working light
11. Air gun
12. CE Mark (EU region)

Option Configuration

1. Controller: Mitsubishi M80VA / FANUC 0i
2. CTS (2/3/7MPa)
3. Spindle ring spray
4. NC rotary table(4th)
5. Workpiece probe
6. Tool setter
7. Water gun
8. Oil skimmer
9. Oil mist collector
10. AC for electric cabinet
11. Linear scale
12. Roller linear guideway

Function Upgrade

Automatic centering function

Align circles, squares, and polygons, or perform oblique angle calculations.

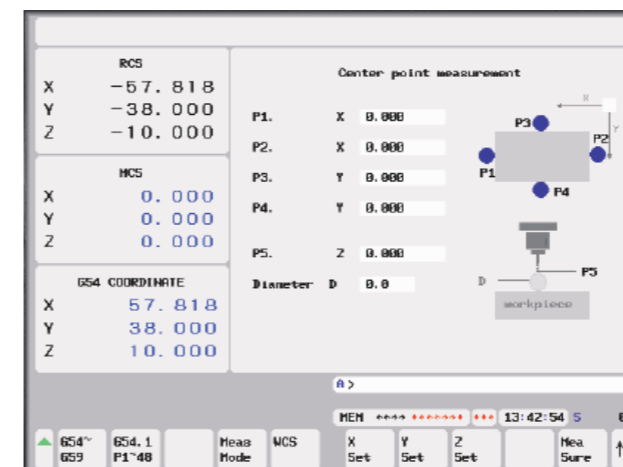

Spindle warm-up function

Warming up the built-in spindle is more convenient with button operation, and the warm-up time can be set by oneself, which can be modified according to actual needs.

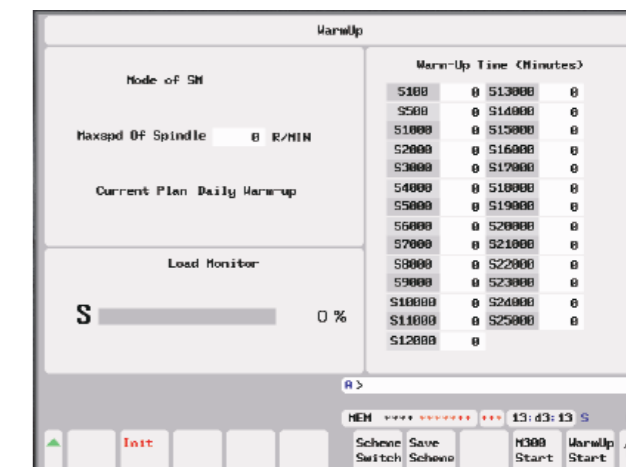

Tool magazine viewing function

Under the random tool magazine, the current corresponding tool position can be viewed, making it more intuitive and convenient to operate.

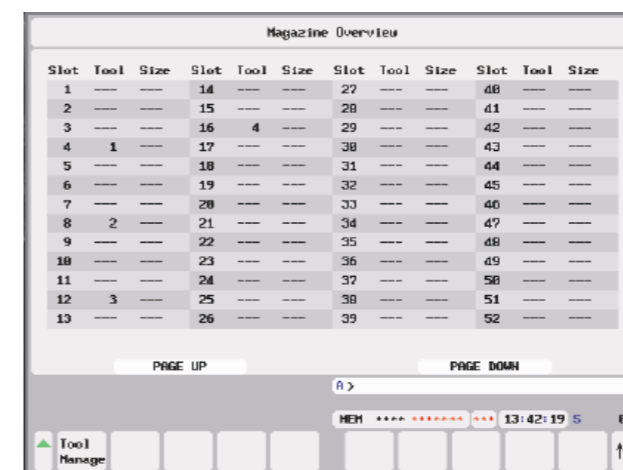

Tool load function

According to different tool settings, if the set load is exceeded during actual machining, the program can be stopped in a timely manner to prevent further damage to the workpiece or tool, reduce losses, and ensure the safety of machining.

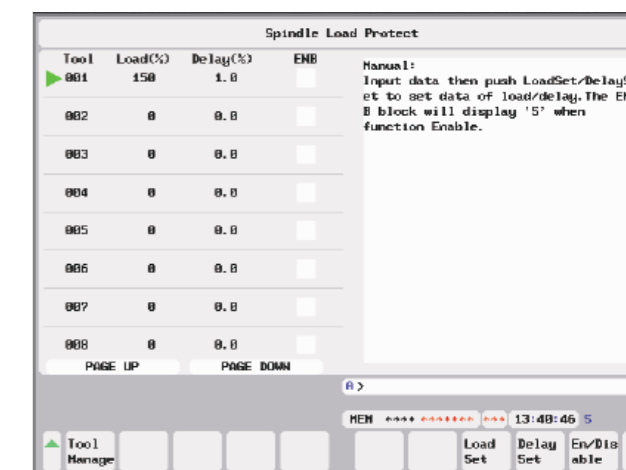

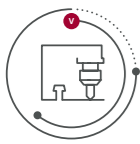

VQ SERIES

VQ series innovative technology fully meets the needs of users, and its consistent aim is high efficiency, high precision, and high reliability; the series are equipped with advanced built-in spindle series and high dynamic response drive systems to enable processing Higher speed, high precision, and efficiency; and endows environmental protection and energy saving characteristics, which is widely used in the processing of components and mold markets.



High Speed, High Precision Built-In Spindle

- High precision:** built-in spindle direct drive, no other vibration source.
- High torque:** two-speed automatic transmission, low speed and high torque, high speed and constant power.
- Efficient start and stop:** zero drive chain, small inertia, starting from 0 to 8000 rpm in just 0.8 seconds.



Optimized Component Design

- High-rigid base components:** large-span bed base, thickened column.
- Lightweight moving parts:** the total weight of the spindle box and built-in spindle 30% lower than the conventional machines.

VQ SERIES



24T Servo Tool Magazine

- Intelligent preparation tool mode:** shorten non-machining time.
- Max.180mm dia. bridge type boring tool.
- Automatic protection door.
- Heavy tool mode: auto slow tool change in this mode.

Professional Automation Interface

- Automatic door.
- Automatic line communication interface.
- Tool automatic compensation & life management.
- Tool magazine broken tool detection.
- Workpiece detecting device.
- Option 4th axis & 5th axis.



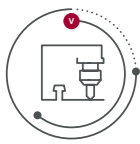

Z SERIES

Z series machine center developed by Haitian Precision through integration of global advanced technologies, is a compact machine with minimized footprint, engineered for high rigidity and superior vibration damping. Widely used for drilling and tapping in non-ferrous metals, 3C industry, and aluminum substrates. Compared to conventional machining centers, it delivers multi-fold improvements in efficiency and quality, making it particularly suitable for 3C and telecommunications industries.



Z SERIES

- Disc type 21T servo tool magazine achieves tool changing through Z-axis movement, making tool changing faster.
- The rotating arm cam-type tool clamping and releasing mechanism realizes tool clamping and releasing through Z-axis movement, providing faster and more stable performance.

- The adoption of high-speed direct-drive spindle, which is especially ideal for the machining of parts and molds made from copper, aluminum, and magnesium alloys.

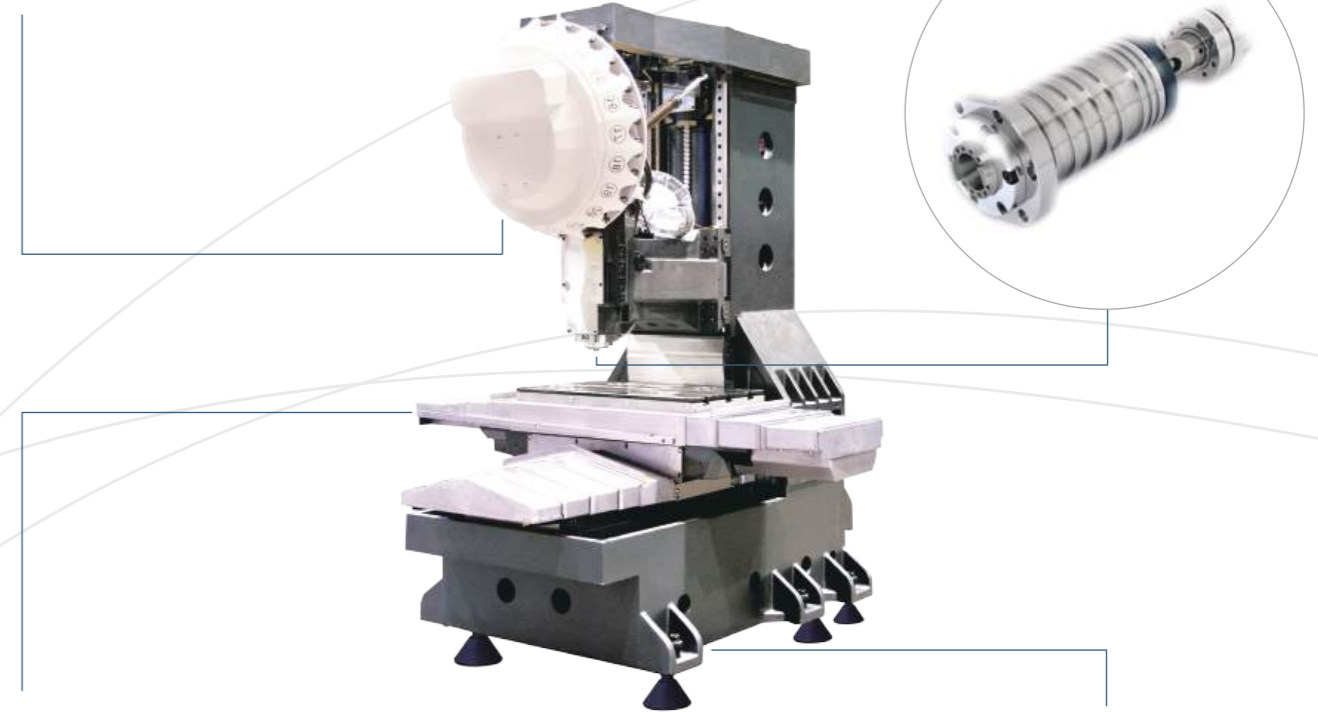

- The synchronous moving covers, where the outer layer and table move while the inner layer remains stationary, ensures a low failure rate of the axis covers.
- The axis covers are compact, and the machine tool occupies a small footprint.

- The oversized foot width of 1000mm ensures stability during high-speed machining

Typical Parts



Cylinder cover

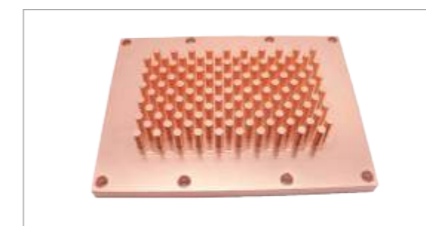

Thermal substrate



Pump cover

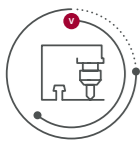

Z Series Dimension Diagram

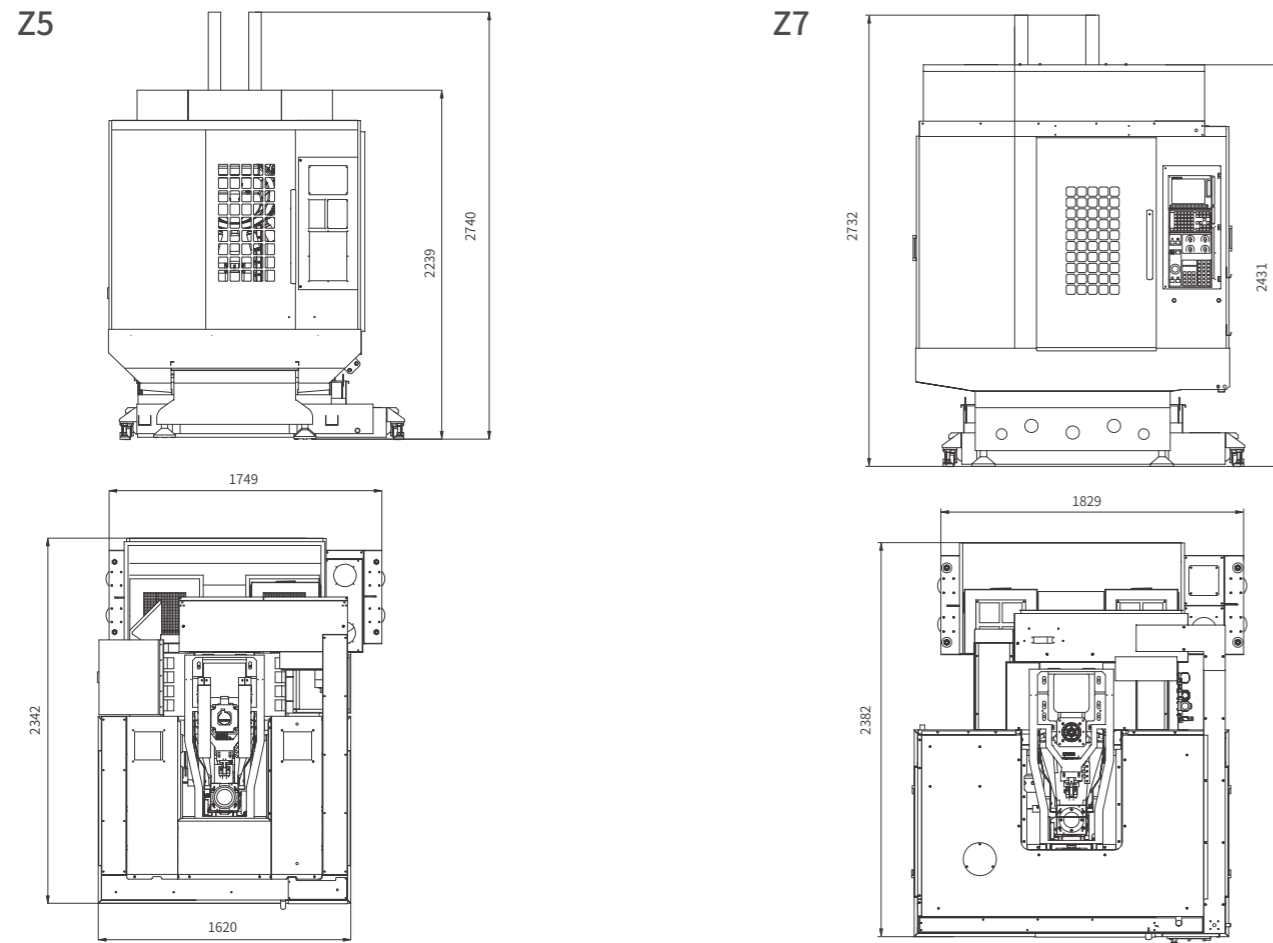

Z SERIES

Items	Unit	Z5	Z7
» Machining Range			
X travel	mm	500	700
Y travel	mm	400	450
Z travel	mm	350	350
Spindle nose to table surface	mm	145-495	145-495
» Table			
Table size	mm	700×420	800×420
Max. table load	kg	250	300
T slot	mm	3×14×125	3×14×125
» Feed			
Rapid traverse (X/Y/Z)	m/min	48/48/48	48/48/48
Cutting feedrate (X/Y/Z)	m/min	30/30/30	30/30/30
Motor power (X/Y/Z)	kW	1.5/1.5/3	1.5/1.5/3
» Spindle			
Drive type	-	Direct-drive	Direct-drive
Max. spindle speed	rpm	20000	20000
Spindle power (S1/S3)	kW	3.7/5.5	3.7/5.5
Spindle torque (S1/S3)	Nm	11.7/21	11.7/21
Spindle taper	-	BT30	BT30
» Tool Magazine			
Capacity	T	21	21
Type	-	Servo	Servo
Max. tool dia. (Adjacent/Vacant)	mm	Φ60/Φ80	Φ60/Φ80
Max. tool length	mm	200	200
Max. tool weight	kg	3kg/T (Total 25kg)	3kg/T (Total 25kg)
Tool change time (T-T)	s	2	2
» Other			
Power capacity	kVA	20	20
Machine weight	t	2.6	2.9
Machine size	mm	1749×2342×2740	1829×2382×2740

Power-torque Diagram

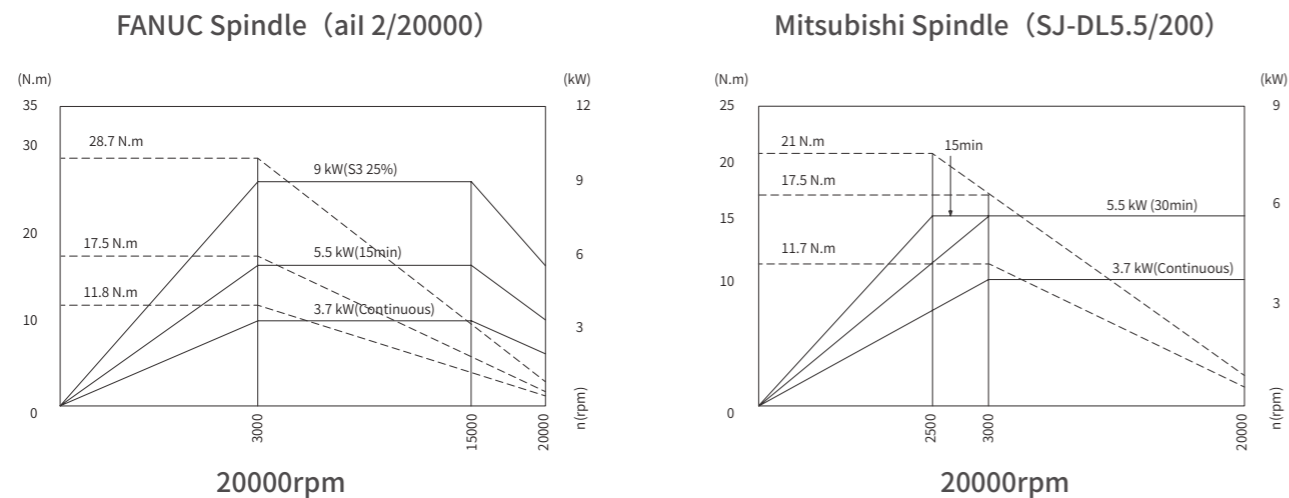

Standard Configuration

1. Controller: MITSUBISHI M80VB
2. 20000rpm directly drive spindle
3. 21T servo type ATC
4. X/Y/Z axis splash cover
5. Oil chiller
6. Full enclosure with top cover
7. Internal rear flushing
8. Pneumatic, lubrication
9. Air gun
10. Water gun
11. 3-color signal lamp and working light
12. Standard accessories
13. Manual chip hopper
14. CE Mark (EU region)

Option Configuration

1. Controller:FANUC 0i
2. Directly drive spindle 12000/24000rpm
3. AC for electrical cabinet (0.3kW)
4. External chain type chip conveyor with iron chip trolley (rear&middle)
5. Internal flush chip system (rear)
6. Oil mist collector
7. Workpiece probe
8. Tool setter

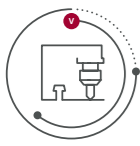

MORE THAN PRECISION

Ningbo Haitian Precision Machinery Co., Ltd. is a listed company specializing in machine tooling industry. It has developed Ningbo Dagang production base, Ningbo Yanshan production base Dalian production base and Shandi production base. It has a modern constant temperature processing and assembly plant of over 570,000 square meters with nearly 2300 employees. It is awarded honors such as "national major technical equipment enterprise", "national high-tech enterprise", and "provincial high-tech research and development center".

